



YASKAWA

YASKAWA AC Drive-V1000 Option **CC-Link** **Technical Manual**

Type SI-C3/V

To properly use the product, read this manual thoroughly and retain for easy reference, inspection, and maintenance. Ensure the end user receives this manual.

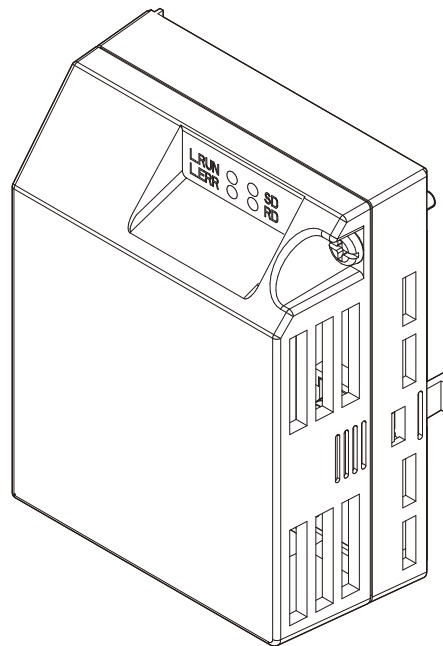



Table of Contents

1 PREFACE AND SAFETY	5
2 PRODUCT OVERVIEW	8
3 RECEIVING	9
4 CC-LINK OPTION COMPONENTS	10
5 INSTALLATION PROCEDURE	12
6 CC-LINK OPTION DRIVE PARAMETERS	18
7 BASIC FUNCTIONS	19
8 CC-LINK DATA TABLE	21
9 TROUBLESHOOTING	24
10 CC-LINK CODE NUMBERS	28
11 SPECIFICATIONS	34

Copyright © 2007 YASKAWA ELECTRIC CORPORATION

All rights reserved. No part of this publication may be reproduced, stored in a retrieval system, or transmitted, in any form, or by any means, mechanical, electronic, photocopying, recording, or otherwise, without the prior written permission of Yaskawa. No patent liability is assumed with respect to the use of the information contained herein. Moreover, because Yaskawa is constantly striving to improve its high-quality products, the information contained in this manual is subject to change without notice. Every precaution has been taken in the preparation of this manual. Yaskawa assumes no responsibility for errors or omissions. Neither is any liability assumed for damages resulting from the use of the information contained in this publication.

1 Preface and Safety

Yaskawa manufactures products used as components in a wide variety of industrial systems and equipment. The selection and application of Yaskawa products remain the responsibility of the equipment manufacturer or end user. Yaskawa accepts no responsibility for the way its products are incorporated into the final system design. Under no circumstances should any Yaskawa product be incorporated into any product or design as the exclusive or sole safety control. Without exception, all controls should be designed to detect faults dynamically and fail safely under all circumstances. All systems or equipment designed to incorporate a product manufactured by Yaskawa must be supplied to the end user with appropriate warnings and instructions as to the safe use and operation of that part. Any warnings provided by Yaskawa must be promptly provided to the end user. Yaskawa offers an express warranty only as to the quality of its products in conforming to standards and specifications published in the Yaskawa manual. **NO OTHER WARRANTY, EXPRESS OR IMPLIED, IS OFFERED.** Yaskawa assumes no liability for any personal injury, property damage, losses, or claims arising from misapplication of its products.

◆ Applicable Documentation

The following manuals are available for the CC-Link Option:

Option Unit

	V1000 Option CC-Link Installation Manual Manual No. : TOBPC73060022
	Read this manual first. The installation manual is packaged with the CC-Link Option and contains a basic overview of wiring, settings, functions, and fault diagnoses.
	V1000 Option CC-Link Technical Manual Manual No. : SIEPC73060022
	The technical manual contains detailed information and command registers. To obtain the technical manual access the site below: http://www.e-mechatronics.com

Yaskawa Drive

	V1000 Series AC Drive Technical Manual
	This manual describes installation, wiring, operation procedures, functions, troubleshooting, maintenance, and inspections to perform before operation. To obtain instruction manuals for Yaskawa products, access the site below: http://www.e-mechatronics.com
	V1000 Series AC Drive Quick Start Guide
	This guide is packaged together with the product. It contains basic information required to install and wire the drive. This guide provides basic programming and simple set-up and adjustment.

◆ Terms

Note: Indicates supplementary information that Yaskawa highly recommends be followed, even though equipment may not be at risk.

Drive: Yaskawa AC Drive -V1000 Series

CC-Link Option: Yaskawa AC Drive -V1000 Option CC-Link

≥ 1011: Indicates a drive feature or function that is only available in drive software version 1011 or later.

◆ Registered Trademarks

- CC-Link is a registered trademark of the CC-Link Partner Association.
- Other company names and product names listed in this manual are registered trademarks of those companies.

◆ Supplemental Safety Information

Read and understand this manual before installing, operating, or servicing this option unit. The option unit must be installed according to this manual and local codes.

The following conventions are used to indicate safety messages in this manual. Failure to heed these messages could result in serious or possibly even fatal injury or damage to the products or to related equipment and systems.

DANGER

Indicates a hazardous situation, which, if not avoided, will result in death or serious injury.

WARNING

Indicates a hazardous situation, which, if not avoided, could result in death or serious injury.

CAUTION

Indicates a hazardous situation, which, if not avoided, could result in minor or moderate injury.

NOTICE

Indicates an equipment damage message.

■ General Safety

General Precautions

- The diagrams in this section may include option units and drives without covers or safety shields to illustrate details. Be sure to reinstall covers or shields before operating any devices. The option should be used according to the instructions described in this manual.
- Any illustrations, photographs, or examples used in this manual are provided as examples only and may not apply to all products to which this manual is applicable.
- The products and specifications described in this manual or the content and presentation of the manual may be changed without notice to improve the product and/or the manual.
- When ordering a new copy of the manual due to damage or loss, contact your Yaskawa representative or the nearest Yaskawa sales office and provide the manual number shown on the front cover.

DANGER

Heed the safety messages in this manual.

Failure to comply will result in death or serious injury.

The operating company is responsible for any injuries or equipment damage resulting from failure to heed the warnings in this manual.

NOTICE

Do not expose the drive to halogen group disinfectants.

Failure to comply may cause damage to the electrical components in the option unit.

Do not pack the drive in wooden materials that have been fumigated or sterilized.

Do not sterilize the entire package after the product is packed.

Do not modify the drive circuitry.

Failure to comply could result in damage to the drive and will void warranty.

YASKAWA is not responsible for any modification of the product made by the user. This product must not be modified.

■ Option Unit Label Warnings

Warning information is displayed on the option unit as shown in the figure below. Follow all warnings and safety instructions when using the product.

When using the drive in an area that may require displaying warning information in Japanese or Chinese, a warning label sticker is provided with the CC-Link Option. This sticker can be placed over the English and French warnings on the front of the CC-Link Option.

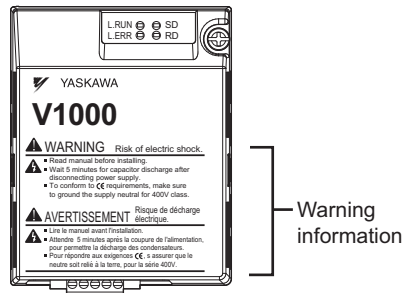

■ Warning Contents

! **WARNING** Risk of electric shock.

- Read manual before installing.
- Wait 5 minutes for capacitor discharge after disconnecting power supply.
- To conform to **CE** requirements, make sure to ground the supply neutral for 400V class.

! **AVERTISSEMENT** Risque de décharge électrique.

- Lire le manuel avant l'installation.
- Attendre 5 minutes après la coupure de l'alimentation, pour permettre la décharge des condensateurs.
- Pour répondre aux exigences **CE**, s'assurer que le neutre soit relié à la terre, pour la série 400V.

2 Product Overview

◆ About This Product

CC-Link Option (Model: SI-C3/V) is designed for connecting a drive to a field network using the CC-Link protocol. This option is conforming to CC-Link Ver.1.10.

By installing the CC-Link Option to a drive, it is possible to do the following from a CC-Link master device:

- operate the drive
- monitor the operation status of the drive
- change parameter settings.



Figure 1 CC-Link Approved

◆ Applicable Model

The CC-Link Option can be used with the drive models in [Table 1](#).

Table 1 Applicable Model

Drive	Software Version <1>
CIMR-V□□A□□□□AA□	≥ 1011
CIMR-V□□A□□□□BA□	≥ 1011
CIMR-V□□A□□□□FA□	≥ 1011

<1> See "PRG" on the drive nameplate for the software version number.

3 Receiving

Please perform the following tasks after receiving the CC-Link Option:

- Inspect the CC-Link Option for damage.
If the CC-Link Option appears damaged upon receipt, contact the shipper immediately.
- Verify receipt of the correct model by checking the information on the nameplate (see [Figure 2](#)).
- If you have received the wrong model or the CC-Link Option does not function properly, contact your supplier.

◆ Contents and Packaging

Table 2 Contents of Package

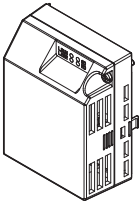
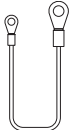
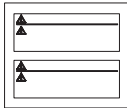
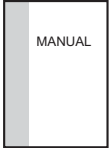
Description:	Option unit	Ground Cables	Warning Label Stickers	Installation Manual
-				
Quantity:	1	4	1	1

◆ Tool Requirements

A Phillips screwdriver (M3, M3.5 to M6 <1> metric or (#1, #2 <1>) U.S. standard size is required to install the CC-Link Option.

<1> Screw sizes vary by drive capacity. Select a screwdriver that matches the drive capacity.

Note: Tools required to prepare CC-Link cables for wiring are not listed in this manual.

4 CC-Link Option Components

◆ CC-Link Option

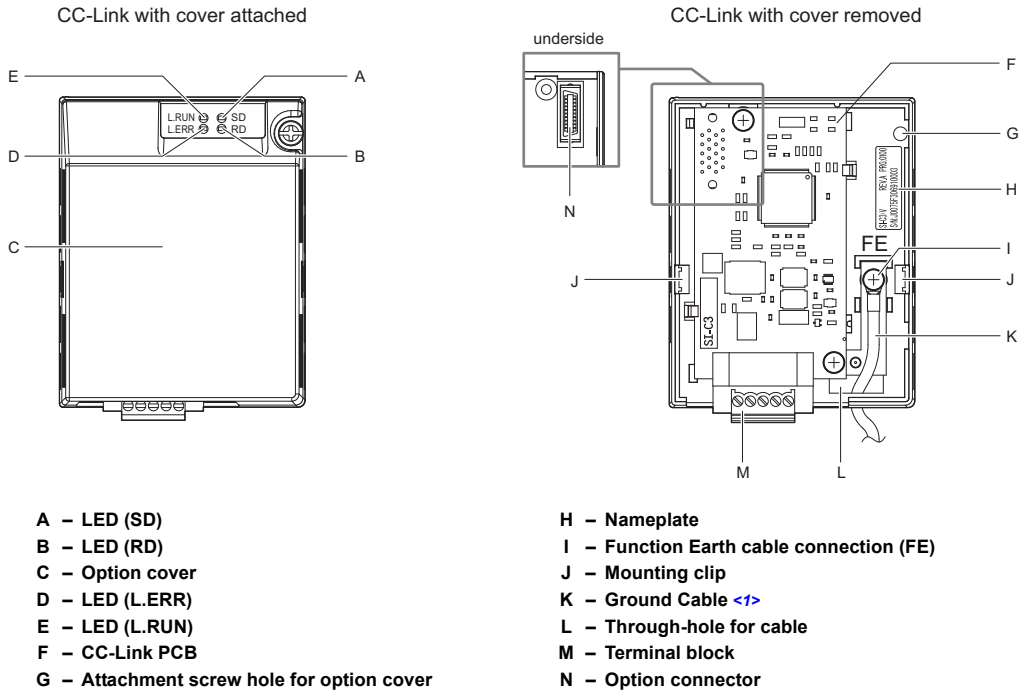

<1> Cables are not connected to the CC-Link Option and are packaged separately in the box.

Figure 2 Option Unit

Note: For details on the LEDs, [Refer to CC-Link Option LED Display on page 11](#) and [Fault LED Display on CC-Link Option Side on page 25](#).

◆ Dimensions

The installed CC-Link Option adds 27 mm to the total depth of the drive.

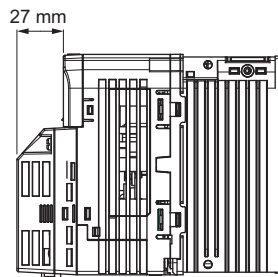

Figure 3 Dimensions

◆ Terminal Block

Table 3 Terminal Descriptions

Terminal	Name	Description
1	DA	Comm. Data +
2	DB	Comm. Data –
3	DG	Signal Ground
4	SLD	Shield
5	SLD	Shield

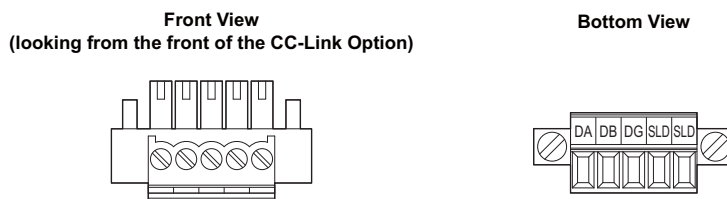

Figure 4 CC-Link Option Terminal Block

◆ CC-Link Option LED Display

Table 4 CC-Link Operation LED Status

Name	Indication		Operating Status	Remarks
	Color	Status		
L.RUN	Green	ON	Normal operation	• Receiving data normally
		OFF	Timed out	• Timed out waiting to receive • Logging onto the network • During reset
L.ERR	Red	ON	CRC error	• CRC error • Station address setting error (F6-10 = 0)
		OFF	During communications	• Normal communications • During reset
SD	Red	ON	Sending data	• Sending data Note: LED may appear to flash with slower baud rates.
		OFF	No data transfer	• No data being sent • During reset
RD	Red	ON	Detecting data received	• Detecting data that was received Note: LED may appear to flash with slower baud rates.
		OFF	Waiting for data	• Data not yet received • During reset

◆ Setting Station Address

Set drive parameter F6-10 to a station address (Range 1 to 64) unique to the network. If set to 0, the L.ERR light will turn on and a Station Address Error (AEr) will occur.

5 Installation Procedure

◆ Section Safety

DANGER

Electrical Shock Hazard

Do not connect or disconnect wiring while the power is on.

Failure to comply will result in death or serious injury.

Disconnect all power to the drive, wait at least five minutes after all indicators are off, measure the DC bus voltage to confirm safe level, and check for unsafe voltages before servicing to prevent electric shock. The internal capacitor remains charged even after the power supply is turned off. The charge indicator LED will extinguish when the DC bus voltage is below 50 Vdc.

WARNING

Electrical Shock Hazard

Do not remove option cover while the power is on.

Failure to comply could result in death or serious injury.

The diagrams in this section may include option units and drives without covers or safety shields to show details. Be sure to reinstall covers or shields before operating any devices. The option should be used according to the instructions described in this manual.

Do not allow unqualified personnel to use equipment.

Failure to comply could result in death or serious injury.

Maintenance, inspection, and replacement of parts must be performed only by authorized personnel familiar with installation, adjustment, and maintenance of this product.

Do not remove option cover while the power to the drive is on.

Failure to comply could result in death or serious injury.

Do not use damaged wires, place excessive stress on wiring, or damage the wire insulation.

Failure to comply could result in death or serious injury.

Fire Hazard

Tighten all terminal screws to the specified tightening torque.

Loose electrical connections could result in death or serious injury by fire due to overheating of electrical connections.

NOTICE

Damage to Equipment

Observe proper electrostatic discharge procedures (ESD) when handling the option unit, drive, and circuit boards.

Failure to comply may result in ESD damage to circuitry.

Never shut the power off while the drive is outputting voltage.

Failure to comply may cause the application to operate incorrectly or damage the drive.

Do not operate damaged equipment.

Failure to comply may cause further damage to the equipment.

Do not connect or operate any equipment with visible damage or missing parts.

Do not use unshielded cable for control wiring.

Failure to comply may cause electrical interference resulting in poor system performance.

Use shielded twisted-pair wires and ground the shield to the ground terminal of the drive.

Properly connect all pins and connectors.

Failure to comply may prevent proper operation and possibly damage equipment.

Check wiring to ensure that all connections are correct after installing the option unit and connecting any other devices.

Failure to comply may result in damage to the option unit.

◆ Wiring Diagram

Table 5 Wiring Diagram

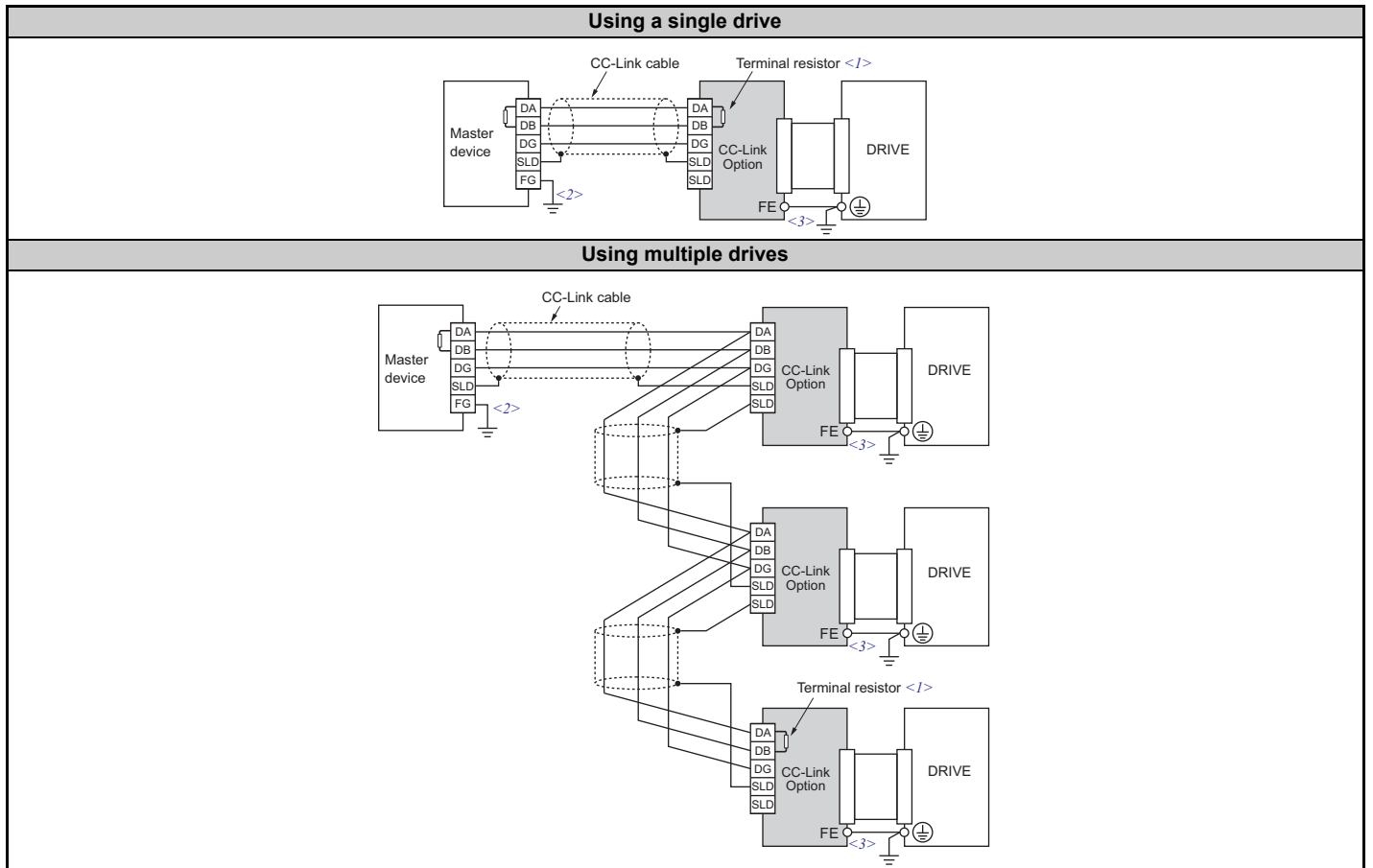

<1> The user must set up the drive for terminal resistor. For instructions, see [Terminal Resistor Connection on page 17](#).

<2> Make sure that the FG terminal on the master drive is grounded properly.

<3> The FE terminal on the CC-Link Option is supplied with a ground cable that should be connected to the ground terminal on the drive.

◆ Installing the Option Unit

Remove the front cover of the drive before installing the CC-Link Option. Follow the directions below for proper installation.

1. Switch off the power supply to the drive.

DANGER! Electrical Shock Hazard - Do not connect or disconnect wiring while the power is on. Failure to comply will result in death or serious injury. Before installing the CC-Link Option, disconnect all power to the drive. The internal capacitor remains charged even after the power supply is turned off. The charge indicator LED will extinguish when the DC bus voltage is below 50 Vdc. To prevent electric shock, wait at least five minutes after all indicators are off and measure the DC bus voltage level to confirm safe level.

2. Remove the front cover.
The original drive front cover may be discarded because it will be replaced by the CC-Link Option cover in step 8.

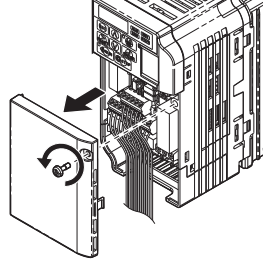

Figure 5 Remove Front Cover

3. Remove the bottom cover and connect the CC-Link Option ground cable to the ground terminal.

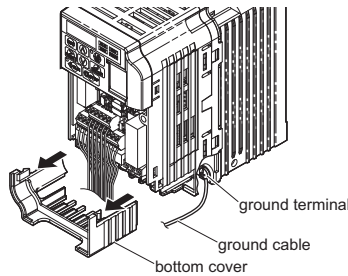
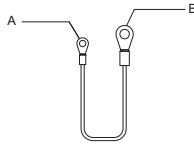

Figure 6 Connect Ground Cable

Note: The four different ground cables packaged with the CC-Link Option connect the unit to different models. Select the proper ground cable from the CC-Link Option kit depending on drive size.



- A – Option unit connection: screw size = M3
- B – Drive-side connection: screw size = M3.5 to M6

Figure 7 Ground Cable

Note: Cover removal for certain larger models with a Terminal Cover:

- Single-Phase 200 V Class: CIMR-V□BA0006 to BA0018
- Three-Phase 200 V Class: CIMR-V□2A0008 to 2A0069
- Three-Phase 400 V Class: All models

Remove the terminal cover before removing the bottom cover to install the CC-Link Option. Replace the terminal cover after wiring the CC-Link Option.

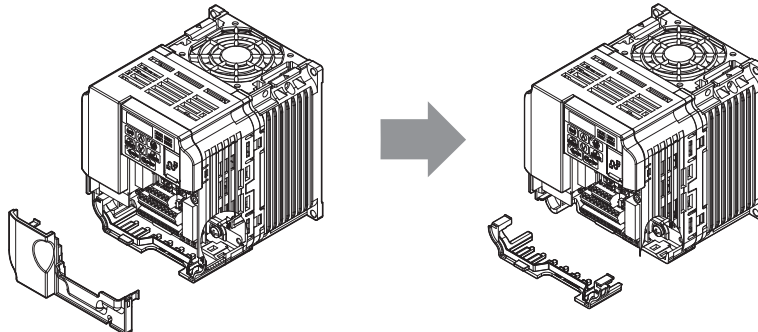

Figure 8 Models with Terminal Cover

4. Reattach the bottom cover.

5. Connect the CC-Link Option to the drive.
Properly secure the tabs on the left and right sides of the CC-Link Option to the drive case.

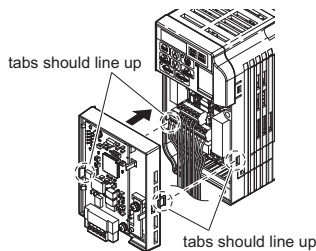

Figure 9 Attach CC-Link Option

6. Connect the ground cable from the drive ground terminal to the CC-Link Option ground.
When wiring the CC-Link Option, pass the ground cable through the inside of the drive bottom cover, then pass the ground cable into the through-hole at the front of the CC-Link Option.

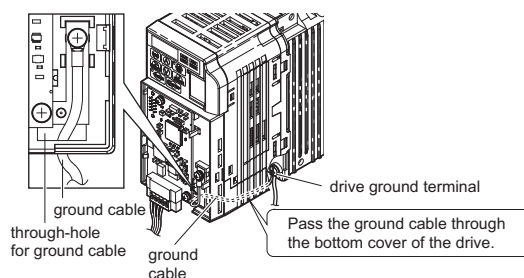

Figure 10 Ground Cable Connection

7. Connect the communications cable to the terminal block. Refer to Procedure on page 16.
8. Attach the CC-Link Option cover to the front of the CC-Link Option.

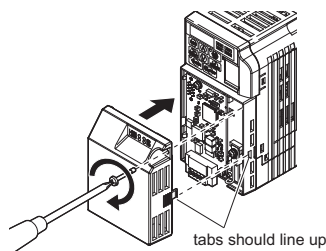

Figure 11 Attach Cover

Note: When using the drive in an area that may require displaying warning information in Japanese or Chinese, a sticker has been provided with the CC-Link Option. This sticker can be placed over the English and French warnings on the front of the CC-Link Option.

◆ Communication Cable Wiring

■ Procedure

Follow the instructions below to connect the communications cable to the terminal block.

NOTICE: Tighten all terminal screws according to the specified tightening torque. Tightening screws too tight could damage the terminal block, and leaving screws too loose can cause a short-circuit or drive malfunction.

1. Connect the communications cable to the terminal block as shown in the diagram below.

Note: Communication lines should be separated from main circuit wiring and other electrical lines. (Tightening torque: 0.22 to 0.25 (N·m))

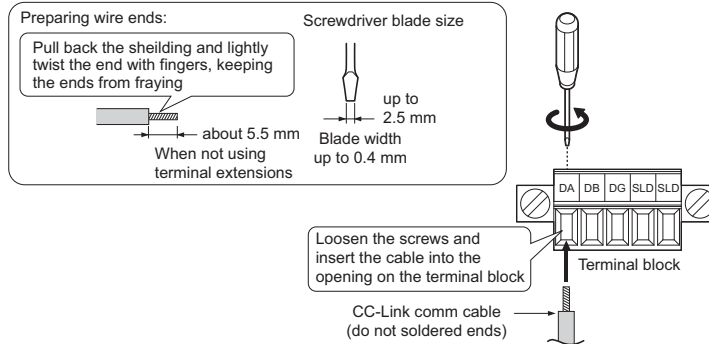

Figure 12 Comm Cable Wiring

2. Ensure all wiring connections are tightened and wire insulation is not pinched in the terminal block. Remove any stray wire strands that touch other terminals.
3. After the terminal block is fully attached to the option unit, tighten the screws on the left and right sides of the terminal block. (Tightening torque: 0.22 to 0.25 (N·m))

Note: Be sure to put the option cover back on after you have completed all necessary wiring.

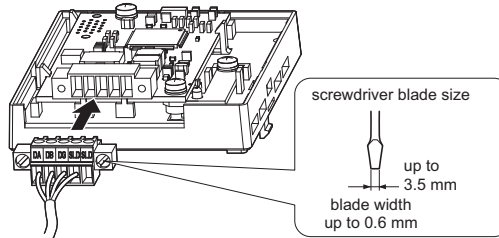

Figure 13 Terminal Block Installation

■ Communication Cable Specifications

Use only CC-Link dedicated communication cable; the Yaskawa warranty does not cover other cable types. For more information on cables, refer to the CC-Link website at <http://www.cc-link.org/>.

Yaskawa recommends using CC-Link cables suitable for the conditions listed in [Table 6](#).

Table 6 Communication Cable Requirements

Cable Type		Specifications	
Cable Type		triple-core shielded twisted-pair cable	
Gauge		8.0 mm max	
Drain Wire		20 lines / 0.18 mm or 24 lines / 0.18 mm	
Electrical Characteristics	Conductor Resistance (20°C)	37.8 Ω/km	
	Insulation Resistance	10000 MΩ·km or more	
	Voltage Tolerance	500 Vdc, 60 s	
	Capacitance (1 kHz)	60 nF/km max	
	Impedance	1 MHz	110 ±15 Ω
		5 MHz	110 ± 6 Ω
Attenuation (20°C)	1 MHz	1.6 dB / 100 m max	
	5 MHz	3.5 dB / 100 m max	

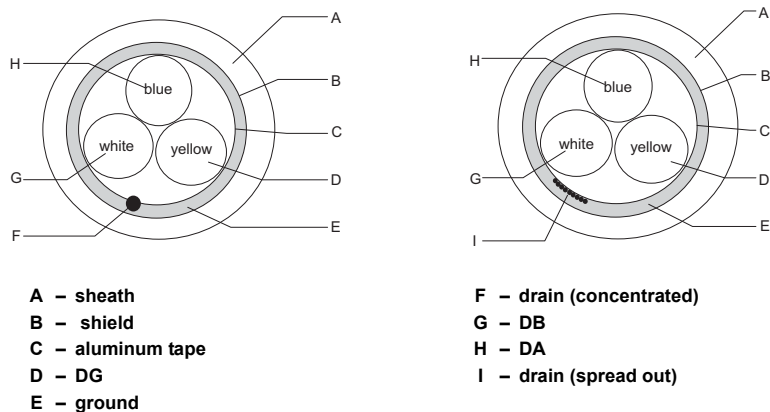

Figure 14 Cable Diagram

■ Terminal Resistor Connection

When the CC-Link Option is the last station connected in a CC-Link network, the terminal resistor needs to be set to that CC-Link Option. Follow the instructions below.

1. Cut the terminal resistor tube as shown.

Note: For the terminal resistor, either use what is already built into the master unit, or use a standard-market resistor of 110 Ω, ±5% (1/2 W).

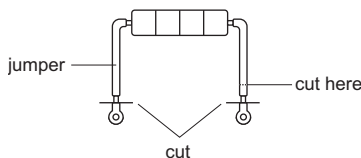

Figure 15 Terminal Resistor

2. Loosen the attachment screw and insert the terminal resistor described in the first step between terminals DA and DB.

Note: Make sure that the option cover is put back on after wiring is complete.

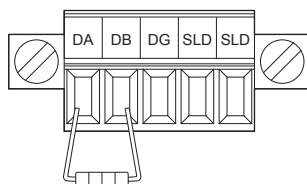

Figure 16 Terminal Resistor Wiring

6 CC-Link Option Drive Parameters

Confirm proper setting of the all parameters in **Table 7** before starting network communications.

Table 7 Parameter Settings

No.	Name	Description	Default
b1-01	Frequency Reference Selection <>	Selects the frequency reference input source 0: Operator - Digital preset speed d1-01 to d1-17 1: Terminals - Analog input terminal A1 or A2 2: MEMOBUS communications 3: Option PCB 4: Pulse Input (Terminal RP)	1
b1-02	Run Command Selection <>	Selects the run command input source 0: Digital Operator - RUN and STOP keys 1: Digital input terminals S1 to S7 2: MEMOBUS communications 3: Option PCB	1
F6-01	Operation Selection after Communications Error	Determines drive response when a bUS error is detected during communications with the CC-Link Option 0: Ramp to Stop 1: Coast to Stop 2: Fast-Stop 3: Alarm Only <>	1
F6-02	External Fault Detection Conditions (EF0)	Sets the condition for external fault detection (EF0) 0: Always detected. 1: Detected only during operation.	0
F6-03	Stopping Method for External Fault from Communication Option	Determines drive response for external fault input (EF0) detection during CC-Link communication 0: Ramp to Stop 1: Coast to Stop 2: Fast-Stop 3: Alarm Only <>	1
F6-04	bUS Error Detection Delay Time	Set the maximum time the drive should wait for a communication error to occur (bUS). Range 0.0 to 5.0 s	0.0 s <>
F6-07 <>	NetRef/ComRef Selection Function	0: Multi-step speed reference disabled (F7 mode) 1: Multi-step speed reference allowed (V7 mode)	1
F6-08 <>	Reset Communication Related Parameters	Determines which communication-related parameters are set back to their original default values when the drive is initialized. 0: Do not reset F6-□□ and F7-□□ parameters when the drive is initialized using parameter A1-03. 1: Rest F6-□□ and F7-□□ parameters when the drive is initialized using parameter A1-03. Note: Setting this parameter does not affect communication-related parameters.	0
F6-10 <>	Station Address <6> <7>	0 to 64	0
F6-11 <>	Comm Speed	0: 156 kbps 1: 625 kbps 2: 2.5 Mbps 3: 5 Mbps 4: 10 Mbps	0

<1> To start and stop the drive with the CC-Link master device using serial communications, set b1-02 to "3". To control the frequency reference of the drive via the master device, set b1-01 to "3".

<2> If set to 3, then the drive will continue to operate when a fault is detected. Take proper measures such as installing an emergency stop switch.

<3> The drive default setting is 2.0 s, but this default setting will automatically be changed to 0.0 s when SI-C3/V is connected.

<4> Software versions 1012 and later have F6-07 and F6-08 both set to 1.

<5> Power must be cycled in order for any setting changes to take affect.

<6> All station addresses must be unique. If set to 0, the L.ERR light will turn on and a Station Address Error (AEr) will occur.

<7> A total of 42 nodes can be connected, assuming that all connections are inverter drives.

The following conditions apply when connecting devices that are not drives to the network:

$$\{(1 \times a) + (2 \times b) + (3 \times c) + (4 \times d)\} \leq 64$$

$$\left(\begin{array}{ll} \text{a: number of units that occupies 1 node} & \text{b: number of units that occupies 2 nodes} \\ \text{c: number of units that occupies 3 nodes} & \text{d: number of units that occupies 4 nodes} \end{array} \right)$$

$$\{(16 \times A) + (54 \times B) + (88 \times C)\} \leq 2304$$

$$\left(\begin{array}{l} \text{A: number of remote I/O nodes..... 64 max} \\ \text{B: number of remote device nodes... 42 max} \\ \text{C: number of local nodes..... 26 max} \end{array} \right)$$

7 Basic Functions

This interface allows the drive to be connected to a CC-Link network as a remote device, making it possible to operate, adjust settings, and monitor the operation status of the drive using the PLC program. Both bit and word data cyclic transmission are available, and high speed communication up to 10 Mbps is possible.

Below is a description of the basic CC-Link functions that can be performed by the PLC.

Note: Set parameters when operating the drive from a PLC. For instructions, see *CC-Link Option Drive Parameters on page 18*.

◆ Switching Between Command/Reference Sources

The Run command, Stop command, and the frequency reference can be entered directly from the operator or given from a separate control device.

To use a separate control device to issue the Run command and frequency reference, the drive needs to be set so that it accepts these commands from an external source.

■ Selecting an External Source

Follow the directions below set the drive up to accept commands from an external controller.

- Using Parameters to Select the Command/Reference Source
- Using the External Terminals to Switch the Command/Reference Source
- Using a PLC as the Command/Reference Source

■ Using Parameters to Select the Command/Reference Source

Selecting the Run Command Source

Set b1-02 (Run Command Selection) to 3 ("Option PCB").

Selecting the Source of the Frequency Reference

Set b1-01 (Frequency Reference Selection) to 3 ("Option PCB").

■ Using the External Terminals to Switch the Command/Reference Source

Selecting the Run Command Source 2

Set b1-16 (Run Command Source 2) to 3 ("Option unit").

Selecting the Source of the Frequency Reference 2

Set b1-15 (Frequency Reference Source 2) to 3 ("Option unit").

Selecting the Run Command and Frequency Reference Source

By setting one of the multi-function input terminals S1 through S7 to supply auxiliary reference (H1-01 to H1-07 = 2), then the frequency reference set to b1-15 and the run command source set to b1-16 will become enabled.

■ Using a PLC as the Command/Reference Source

Using Parameters to Switch Sources

Note: By setting H1-□□ = 2, then parameters b1-15 and b1-16 will become enabled when that terminal is switched on.

- Selecting the Run Command Source
Send write data "3" for command code 2181H to the drive.
The setting for parameter b1-02 changes to "3".
- Frequency Reference Source Selection
Send write data "3" for command code 2180H to the drive.
The setting for parameter b1-01 changes to "3".

Using NetRef and NetCtrl

It is also possible to change the source of the frequency reference and the Run command using remote register RW_{w2} command code 00FBH. If the power is shut off, however, the drive will use the original setting for the command/reference source once the power is turned back again. This method should therefore only be used when briefly switching between command/reference sources.

7 Basic Functions

■ Command/Reference Source Priority Using a PLC

Run Command Source

Table 8 Run Command Source Priority

NetCtrl	Setting Status					
	1	0	0	0	0	0
LOCAL/REMOTE Selection	–	LOCAL	REMOTE			
Switching Command Source	–	–	OFF		ON	
Run Command Selection 1 b1-02	–	–	3	not 3	–	–
Run Command Selection 2 b1-16	–	–	–	–	3	not 3
Run Command Source	PLC	Operator	PLC	Determined by b1-02	PLC	Determined by b1-16

Note: Dash indicates that the setting has no effect on the source of the Run command.

Frequency Reference Source

Table 9 Frequency Reference Source Priority

NetRef	Setting Status					
	1	0	0	0	0	0
LOCAL/REMOTE Selection	–	LOCAL	REMOTE			
Switching Reference Source	–	–	OFF		ON	
Frequency Reference Selection 1 b1-01	–	–	3	not 3	–	–
Frequency Reference Selection 2 b1-15	–	–	–	–	3	not 3
Frequency Reference Source	PLC	Operator	PLC	Determined by b1-01	PLC	Determined by b1-15

Note: 1. When the multi-function input terminals are set up for Multi-Step Speed operation, parameters d1-01 through d1-16 take priority as the source of the frequency reference (assuming that F6-07 = 1).
 2. Dash indicates that the setting has no effect on the source of the frequency reference.
 3. Refer to the V1000 Technical Manual for more details on parameter settings.

◆ Monitors

The user can monitor drive operating status from a PLC.

To do so, the monitor should be set up as follows:

1. Sets the monitor code to the remote register RW_{W0} .
2. Switch the RYC signal on.
 - Data for the monitor code is stored in the PLC's buffer memory.

Note: Monitor codes and units are listed in [Monitor Codes on page 30](#).

◆ Reading and Setting Parameters

The PLC can write drive parameters, read drive data and operation status, and change settings.

Follow the directions below.

1. Set the command code to remote register RW_{W2} .
 - Set the write data to RW_{W3} as needed.
2. Switch on the RYF signal (request to execute the command code).
 - Drive executes the process and reply data that correspond with the command code.
 - Command codes for drive parameters should be calculated by adding the values shown below to the MEMOBUS register number.

Read command code: MEMOBUS register + 1000H

Write command code: MEMOBUS register + 2000H

EXAMPLE: Acceleration time command code for C1-01 is 200H. Get the read command code by adding 1000H, yielding 1200H

Note: 1. For a list of command codes, write data units, and setting ranges, refer to [Command Codes on page 28](#) and [Extended Command Codes on page 29](#).
 2. Refer to the MEMOBUS/Modbus Data Table in Appendix C of the V1000 Technical Manual for a list of monitor data using the MEMOBUS/Modbus message area.

8 CC-Link Data Table

◆ Remote I/O

The drive takes up a single station address in the buffer memory or the PLC. The table below shows the drive I/O as seen from the PLC side.

Note: Refer to the PLC's programming manual for information on the PLC's buffer memory.

■ PLC → Drive

Table 10 Remote I/O Table (PLC → Drive)

Signal	Name	Description	Default
RY0	Forward Run	ON: Forward Run Command, OFF: Stop	–
RY1	Reverse Run	ON: Reverse Run Command, OFF: Stop	–
RY2	Terminal S3 Function	Multi-function input: H1-03	(H1-03 = 24: External Fault)
RY3	Terminal S4 Function	Multi-function input: H1-04	(H1-04 = 14: Fault Reset)
RY4	Terminal S5 Function	Multi-function input: H1-05	(H1-05 = 3: Multi-Step Speed 1)
RY5	Terminal S6 Function	Multi-function input: H1-06	(H1-06 = 4: Multi-Step Speed 2)
RY6	Terminal S7 Function	Multi-function input: H1-07	(H1-07 = 6: Jog Reference)
RY7, 8	Reserved	–	–
RY9	Drive Output Interrupt	ON: Motor coasts to stop. OFF: Drive will begin operating as soon as a Run command is given.	–
RYA	External Fault	ON: External Fault Input (EF0)	–
RYB	Motor Revolutions / Output Frequency Switch	Data contents for the remote register RW _{R1} switches between motor revolutions and output frequency.	Motor rotations are displayed only when H6-01 = 3 and A1-02 = 0.
RYC	Monitor Reference	ON: Monitor data specified in the monitor code is set to remote register RW _{R0} .	–
RYD	Frequency Reference 1	Frequency set to remote register RW _{W1} becomes the operating frequency for the drive.	–
RYE	Frequency Reference 2	Sets the frequency in the remote register RW _{W1} to parameter d1-01 (Frequency Reference 1) and as the drive's main frequency reference at the same time. Note: If the frequency reference is set to be provided by the LED operator (i.e., b1-01 = 0), then switching on RYE changes the frequency reference.	All parameter settings are saved when this flag is switched on. Triggered by the rising edge of the signal.
RYF	Command Code Execute Request	Request to execute the command code.	Triggered by the rising edge of the signal.
RY10 to 13	Reserved	–	–
RY14	Terminal S1 Function	Multi-function input: H1-01	Function is disabled when for the Forward Run Command (H1-01 = 40).
RY15	Terminal S2 Function	Multi-function input: H1-02	Function is disabled when for the Reverse Run Command (H1-02 = 41).
RY16 to 19	Reserved	–	–
RY1A	Fault Reset	Resets a drive fault	–
RY1B to 1F	Reserved	–	–

- Note:**
1. If making frequent setting changes, use RYD (Frequency Reference 1 flag) for setting the register. Using RYE (Frequency Reference 2 flag) too often can shorten the performance life of the drive's internal memory.
 2. Although RYE and RYF are triggered by the rising edge of the signal, they are otherwise enabled depending on the value that is input.
When switching between monitors using RYC (Monitor Reference), RYC needs to be turned off and then back on again after the monitor code has been changed.

■ Drive → PLC

Table 11 Remote I/O Table (Drive → PLC)

Device	Signal Name	Description	Default
RX0	Forward Run	ON: Forward Run Command Present (includes DC Injection Braking) OFF: No Forward Run Command	-
RX1	Reverse Run	ON: Reverse Run Command Present OFF: No Reverse Run Command (includes DC Injection Braking)	-
RX2	Terminals MA, MB, MC Function	Multi-function output: H2-01	(H2-01 = E: Fault)
RX3	Speed Agree	ON: Output frequency is between frequency reference and the detection width set to L4-02.	-
RX4	During Stall Prevention	-	-
RX5	During Undervoltage	-	-
RX6	Terminal P1 Function	Multi-function output: H2-02	(H2-02 = 0: During Run)
RX7	Terminal P2 Function	Multi-function output: H2-03	(H2-03 = 2: Speed Agree 1)
RX8, 9	Reserved	-	-
RXA	CC-Link Option Fault	Comm. error between drive and CC-Link device	-
RXB	Monitoring Motor Revolutions	ON: Currently monitoring motor revolutions.	Data is stored in remote register RW _{R1} .
RXC	Obtain Monitor Data	ON: Monitor data has been updated.	-
RXD	Frequency Setting Ready 1	ON: Displays the main frequency reference that has been set.	-
RXE	Frequency Setting Ready 2	ON: Displays the data set to d1-01 (Frequency Reference 1). Note: Also sets the main frequency reference at the same time.	-
RXF	Command Code Execute Complete	ON: Displayed after the specified command code has been executed. RXF signal switches off when the RYF command is no longer present.	-
RX10 to 19	Reserved	-	-
RX1A	Error	ON: Fault occurred on the drive side.	-
RX1B	Remote Station Ready	ON: Drive is ready to operate.	-
RX1C to 1F	Reserved	-	-

Note: If making frequent setting changes, use RYD (Frequency Reference 1 flag) for setting the register. Using RYE (Frequency Reference 2 flag) too often can shorten the performance life of the drive's internal memory.

◆ Remote Register

■ PLC → Drive

Table 12 Remote Register (PLC → Drive)

Remote Register	Name	Description	Request Flag
RW _{W0}	Monitor Code	<ul style="list-style-type: none"> Sets the code number of the items to be displayed by the monitor. (Refer to Monitor Codes on page 30). Once the monitor code has been set, the monitor value is stored in register RW_{R0} by enabling RYC (the monitor execute request flag). While RW_{R0} is updated, RXC (during monitor flag) remains on. 	RYC (Monitor Execute Request)
RW _{W1}	Frequency Setting	<ul style="list-style-type: none"> Specifies the source of the frequency reference. The value set to this register becomes the main frequency reference whenever RYD (frequency setting reference 1) is enabled. When RYE (frequency setting reference 2 flag) is enabled, then the value for frequency reference 1 is written and saved to EEPROM <I>. Note: Parameter o1-03 determines the setting units for the frequency reference. 	<ul style="list-style-type: none"> RYD (Frequency Reference 1) RYE (Frequency Reference 2)
RW _{W2}	Command Code	<ul style="list-style-type: none"> Sets the command code to execute functions such as the fault reset, fault history, parameter read, and so on. (Refer to Command Codes on page 28, Extended Command Codes on page 29.) When RYF (command code execution request flag) is enabled, the drive executes the specified command. Once the command has been carried out, RXF switches on. Note: The value set to RW_{W3} (write data) should be adjusted accordingly to match changes to any parameter settings. 	RYF (Command Code Execute Request)
RW _{W3}	Write Data	<ul style="list-style-type: none"> Sets the value to be used along with RW_{W2} (Command Code) as needed. RYF (command code execution request flag) needs to be enabled after the command code and write data have been set. 	

<I> Refrain from saving data to the EEPROM excessively because the EEPROM used in the drive can only be written to 100,000 times.

■ Drive → PLC

Table 13 Remote Register (Drive → PLC)

Remote Register	Name	Description	Check Flag
RW _{R0}	Monitor Data	<ul style="list-style-type: none"> Monitor data is stored according to RW_{w0} (Monitor Code). Monitor data is updated while RYC (monitor execute request flag) is enabled. RXC (during monitor) remains on as data is updated. 	RXC (while monitoring)
RW _{R1}	Output Frequency	<ul style="list-style-type: none"> Output frequency has been set without any errors. Set in the units specified by o1-03 (Frequency Reference Setting Units). Example: When o1-03 = 0, the frequency is displayed in Hz. When o1-03 = 2, the frequency is displayed as min⁻¹. When operating with a PG encoder, the motor revolutions are stored as min⁻¹. Here, RXB (actual motor rotations) is enabled. When RYB (motor rotations / output frequency switch) is enabled, the value stored to this register changes from the number motor rotations to the output frequency. 	—
RW _{R2}	Response Code	<ul style="list-style-type: none"> Sets 00H when there are no problems with RW_{w2} (Command Code) and RW_{w3} (Write Data). Sets 01H through 03H if an error occurs. Response Code: 00h: Normal 01h: Write-mode error (attempted to write during run, etc.) 02h: Command code error 03h: Data setting range error 	RXF (Command Code Execute Complete)
RW _{R3}	Read Data	Data is set according to the command code.	

How o1-03 Determines Data in RW_{R1}Table 14 RW_{R1} Data

Frequency Reference Setting and Display Units (o1-03)	Frequency Reference Data Contents (RW _{R1})
0	Hz (output frequency)
1	% (percent of maximum output frequency)
2	min ⁻¹ (calculated from the maximum output frequency and the number of motor poles)
3	User-set (according to parameter o1-10 and o1-11)

Note: Refer to the V1000 Technical Manual for more details on parameter settings.

9 Troubleshooting

◆ Drive-Side Error Codes

Drive-side error codes appear on the drive's LED operator. Causes of the errors and corrective actions are listed in [Table 15](#). For additional error codes that may appear on the LED operator screen, refer to the V1000 Technical Manual.

■ Faults

Both bUS (CC-Link Option Communication Error) and EF0 (External Fault Input from the CC-Link Option) can appear as an alarm or as a fault. When a fault occurs, the digital operator ALM LED remains. When an alarm occurs, the digital operator ALM LED flashes.

If communication stops while the drive is running, answer the following questions to help remedy the fault:

- Is the CC-Link Option properly installed?
- Is the communication line properly connected to the CC-Link Option? Is it loose?
- Is the PLC program working? Has the PLC CPU stopped?
- Did a momentary power loss interrupt communications?

Table 15 Fault Display and Possible Solutions

LED Operator Display		Fault Name
bUS	BUS	CC-Link Option Communication Error
		After establishing initial communication, the connection was lost. Only detected when the run command or frequency reference is assigned to the option (b1-03 = 3 or b1-02 = 3).
Cause		Possible Solution
Master controller (PLC) has stopped communicating. Communication cable is not connected properly.		Check for faulty wiring. ⇒ Correct any wiring problems.
A data error occurred due to noise		Check the various options available to minimize the effects of noise. ⇒ Take steps to counteract noise in the control circuit wiring, main circuit lines, and ground wiring. ⇒ If a magnetic contactor is identified as a source of noise, install a surge absorber to the contactor coil. ⇒ Use cables recommended by Yaskawa, or another type of shielded line. The shield should be grounded on the PLC side and on the CC-Link Option side.
CC-Link Option is damaged.		⇒ If there are no problems with the wiring and the error continues to occur, replace the CC-Link Option.

LED Operator Display		Fault Name
EF0	EF0	External Fault Input from CC-Link Option
		The alarm function for an external device has been triggered.
Cause		Possible Solution
An external fault is being sent from the master controller (PLC).		⇒ Remove the cause of the external fault. ⇒ Reset the external fault input from the PLC device.
Problem with the PLC program		⇒ Check the program used by the PLC and make the appropriate corrections.

LED Operator Display		Fault Name
oFA00	oFA00	CC-Link Option Fault (port A)
		CC-Link Option is not properly connected.
Cause		Possible Solution
Non-compatible option connected to the drive		⇒ Connect an option that is compatible with the drive.

LED Operator Display		Fault Name
oFA01	oFA01	CC-Link Option Fault (port A)
		CC-Link Option is not properly connected.
Cause		Possible Solution
Problem with the connectors between the drive and CC-Link Option		⇒ Turn the power off and check the connectors between the drive and CC-Link Option.

LED Operator Display		Fault Name
oFA03	oFA03	CC-Link Option Fault (port A)
		CC-Link Option self-diagnostics error.
Cause		Possible Solution
CC-Link Option hardware fault		⇒ Replace the CC-Link Option. Contact Yaskawa for assistance.

LED Operator Display		Fault Name
oFA04	oFA04	CC-Link Option Fault (port A)
		CC-Link Option Flash write mode
Cause		Possible Solution
CC-Link Option hardware fault		⇒ Replace the CC-Link Option. Contact Yaskawa for assistance.

LED Operator Display		Fault Name
oFA30 to oFA43	oFA30 to oFA43	CC-Link Option Fault (port A)
		Communication ID error
Cause		Possible Solution
CC-Link Option hardware fault		⇒ Replace the CC-Link Option. Contact Yaskawa for assistance.

■ Minor Faults and Alarms

LED Operator Display		Minor Fault Name	
AEr	AEr	Station Address Error	
		CC-Link Option is set to an address outside the allowable setting range.	
Cause		Possible Solution	Minor Fault (H2-□□ = 10)
Address outside the specified address range		⇒ Set F6-10 to an address within the specified range.	YES

LED Operator Display		Minor Fault Name	
CALL	CALL	Serial Communication Transmission Error	
		Communication has not yet been established.	
Cause		Possible Solution	Minor Fault (H2-□□ = 10)
Communication wiring is faulty, there is a short circuit, or something is not connected properly.		Check for wiring errors. ⇒ Correct the wiring. ⇒ Remove and ground shorts and reconnect loose wires.	YES
Programming error on the master side		⇒ Check communications at start-up and correct programming errors.	
Communication circuitry is damaged.		Perform a self-diagnostics check. ⇒ Replace the drive if the fault continues to occur.	

◆ Fault LED Display on CC-Link Option Side

■ Checking LED Operation

Table 16 LED Display

L.RUN	Switches on when data is being received normally. Turns off when the receive data is interrupted.
SD	Lights whenever the drive is sending data.
RD	Lights whenever the drive is receiving data.
L.ERR	Lights when a CRC or abort error occurs.

Note: If communication stops while the drive is running, check the following:

- Is the CC-Link properly installed?
- Is the CC-Link communication line connected to the CC-Link Option correctly? Is it loose?
- Is the PLC program working? Has the PLC CPU stopped?
- Did a momentary loss in power interrupt communications?

■ **Faults that Occur with a Single Drive**

The example below demonstrates how to read the LED display on the CC-Link Option to determine the cause of a fault and corrective action.

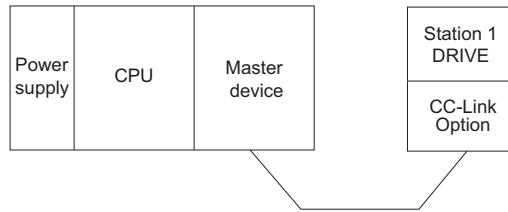

Figure 17 Connecting a Single Drive

Table 17 LED Fault Display for CC-Link Option with a Single Drive

○: On / □: Flashing / ×: Off / *: Either on or off

L.RUN	SD	RD	L.ERR	Cause	Possible Solution
○	○	○	×	Normal communications	–
○	○	○	□	Error has occurred but communication is normal	⇒Remove the source of noise interference.
○	○	×	□	Problem with the hardware	⇒Try cycling the power. Replace the CC-Link Option if the problem continues.
○	○	×	×	Problem with the hardware	⇒Try cycling the power. Replace the CC-Link Option if the problem continues.
○	×	○	□	CRC error with the data received, and no response can be sent	⇒Remove the source of noise interference.
○	×	○	×	No station address received	⇒Check the PLC program and the operation where the problem occurred.
○	×	×	□	Problem with the hardware	⇒Try cycling the power. Replace the CC-Link Option if the problem continues.
○	×	×	×	Problem with the hardware	⇒Try cycling the power. Replace the CC-Link Option if the problem continues.
×	○	○	□	A response was received after polling, but a CRC error occurred when the reflex data was checked	⇒Remove the source of noise interference.
×	○	○	×	Problem with the hardware	⇒Try cycling the power. Replace the CC-Link Option if the problem continues. ⇒See if the master device is actually set to function as a remote device station.
×	○	×	□	Problem with the hardware	⇒Try cycling the power. Replace the CC-Link Option if the problem continues.
×	○	×	×	Problem with the hardware	⇒Try cycling the power. Replace the CC-Link Option if the problem continues.
×	×	○	□	CRC errors occurs when the station address is checked.	⇒Remove the source of noise interference.
×	×	○	×	<ul style="list-style-type: none"> • No station address • Cannot receive station address due to noise interference 	⇒Remove the source of noise interference.
×	×	×	□	Problem with the hardware	⇒Try cycling the power. Replace the CC-Link Option if the problem continues.
×	×	×	×	Data cannot be received (CC-Link communications cable may be disconnected)	⇒Check the wiring.
×	×	*	○	The station address or communications speed is set incorrectly	⇒Enter the proper settings and cycle power.
○	○	○	□	The station address or communications speed was changed without cycling power afterwards.	⇒Return any incorrect settings to their original values and cycle power. ⇒Enter the proper settings and cycle power.

Note: SD and RD may appear to flash with slower baud rates.

■ Faults when running multiple drives

The example below demonstrates how to read the LED display on the CC-Link Option to determine the cause of a fault and the corrective action to take when multiple drives are running from the same network. The example assumes that SW, M/S, and PRM on the master device are all off, indicated that the master device is operating normally.

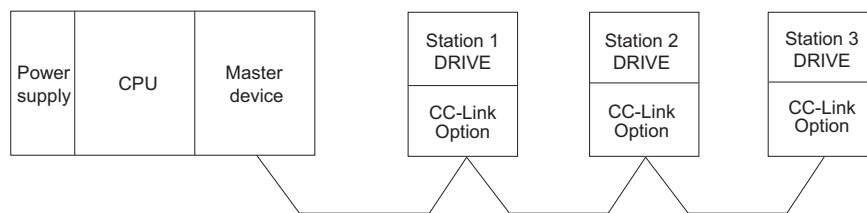

Figure 18 Connecting Multiple Drives on the Same Network

Table 18 LED Fault Display for CC-Link Option with Multiple Drives

○: On / □: Flashing / ×: Off / *: Either on or off

Master	LED Status			Cause	Corrective Action
	Remote Device Addresses (CC-Link Option)				
	Station 1	Station 2	Station 3		
	L.RUN ○ SD ○ RD ○ L.ERR ×	L.RUN ○ SD ○ RD ○ L.ERR ×	L.RUN ○ SD ○ RD ○ L.ERR ×	Normal operation	-
	L.RUN × SD × RD × L.ERR ×	L.RUN ○ SD ○ RD ○ L.ERR ×	L.RUN ○ SD ○ RD ○ L.ERR ×	The CC-Link Option for the first station is not properly installed.	⇒Make sure the CC-Link Option and drive are connected together properly.
	L.RUN * SD * RD * L.ERR *	L.RUN ○ SD ○ RD ○ L.ERR ×	L.RUN ○ SD ○ RD ○ L.ERR ×	The CC-Link Option for the first station is damaged (most often all LEDs are out). Note: Sometimes an error will appear on the drive's LED operator	⇒Replace the CC-Link Option.
	L.RUN ○ SD ○ RD ○ L.ERR ×	L.RUN × SD × RD × L.ERR ×	L.RUN × SD × RD × L.ERR ×	Because L.RUN after Station 2 is off, either the comm. line between Station 1 and Station 2 is disconnected, or the terminal block has come loose.	Make sure components are connected correctly, using the LEDs as a guide to indicate a proper connection.
TIME LINE or TIME LINE	○ ○ × ○	L.RUN × SD * RD * L.ERR ×	L.RUN × SD * RD * L.ERR ×	Comm cable has short-circuited	⇒Look for any short-circuits along the communication lines and fix any problems.
	L.RUN × SD * RD * L.ERR *	L.RUN × SD * RD * L.ERR *	L.RUN × SD * RD * L.ERR *	Comm cable is not wired properly	⇒Check the wiring for the CC-Link Option terminal block and fix any mistakes.
	L.RUN × SD * RD ○ L.ERR ×	L.RUN ○ SD ○ RD ○ L.ERR ×	L.RUN × SD * RD ○ L.ERR ×	The CC-Link Options for Station 1 and Station 3 have been assigned the same address.	⇒Enter the correct station address and cycle power.
	L.RUN ○ SD ○ RD ○ L.ERR ×	L.RUN × SD × RD ○ L.ERR ×	L.RUN ○ SD ○ RD ○ L.ERR ×	The CC-Link Option for Station 2 has a different communication speed setting than the master device.	⇒Set the correct communication speed and cycle power.
	L.RUN ○ SD ○ RD ○ L.ERR ×	L.RUN ○ SD ○ RD ○ L.ERR ×	L.RUN ○ SD ○ RD ○ L.ERR □	The settings for the CC-Link Option connected to Station 3 were changed without cycling power.	⇒Return any incorrect settings to their original values and cycle power. ⇒Enter the proper settings and cycle power.
	L.RUN × SD × RD ○ L.ERR ○	L.RUN ○ SD ○ RD ○ L.ERR ×	L.RUN ○ SD ○ RD ○ L.ERR ×	Parameters related to the CC-Link Option (F6-10, F6-11) for Station 1 are set outside the acceptable range.	⇒ Set F6-10 and F6-11 correctly and cycle power.
TIME LINE or TIME LINE	× × ○ ×	L.RUN ○ SD ○ RD ○ L.ERR ×	L.RUN ○ SD ○ RD ○ L.ERR ○	The CC-Link Option connected to Station 2 is experiencing noise interference (L.RUN is sometimes off).	⇒Make sure that the CC-Link Options, drives, and master device are all grounded properly.
	L.RUN ○ SD ○ RD ○ L.ERR ×	L.RUN ○ SD ○ RD ○ L.ERR ○	L.RUN ○ SD ○ RD ○ L.ERR ○	Noise interference along the cable running between Station 2 and Station 3. (L.RUN is sometimes off)	⇒Reconnect the comm line to the SLD terminal on the CC-Link Option. Also make sure that all power cables are properly separated from comm lines (at least 100 mm away).
	L.RUN ○ SD ○ RD ○ L.ERR ×	L.RUN ○ SD ○ RD ○ L.ERR ×	L.RUN ○ SD ○ RD ○ L.ERR ○	Terminal resistor not connected. (L.RUN is sometimes off)	⇒Set up the final station in the series for terminal resistor.

10 CC-Link Code Numbers

◆ Command Codes

Table 19 Command Codes

Command Code	Name	Description
1181H	Read Run command source	0: LED operator 1: Control circuit terminals (sequencer input) 2: MEMOBUS communications 3: Option unit
1180H	Read frequency reference source	0: LED operator 1: Control circuit terminals (analog input) 2: MEMOBUS communications 3: Option unit 4: Pulse train input
2181H	Write Run command source	0: LED operator 1: Control circuit terminals (sequencer input) 2: MEMOBUS communications 3: Option unit
2180H	Write frequency reference source	0: LED operator 1: Control circuit terminals (analog input) 2: MEMOBUS communications 3: Option unit 4: Pulse train input
0074H	Fault History 1	Reads the contents from U3-01.
0075H	Fault History 2	Reads the contents from U3-02.
0076H	Fault History 3	Reads the contents from U3-03.
0077H	Fault History 4	Reads the contents from U3-04.
0078H	Fault History 5	Reads the contents from U3-05.
0079H	Fault History 6	Reads the contents from U3-06.
007AH	Fault History 7	Reads the contents from U3-07.
0080H	Fault History 8	Reads the contents from U3-08.
0081H	Fault History 9	Reads the contents from U3-09.
0082H	Fault History 10	Reads the contents from U3-10.
006DH	Read frequency reference (RAM)	Reads the drive's frequency reference from RAM.
006EH	Read frequency reference (EEPROM)	Reads the frequency reference from EEPROM.
007BH	Read LOCAL/REMOTE status	0: 0 = Frequency reference is supplied by CC-Link. 1: 0 = FWD/REV Run command is supplied by CC-Link. 8: 1 = During Stall Prevention.
00FBH	Write LOCAL/REMOTE status	0: 0 = Frequency reference from CC-Link is enabled. 1: 0 = FWD/REV Run command from CC-Link is enabled. When power is cycled, however, the source is determined by parameters b1-01 and b1-02. If one of the multi-function relay input terminals is set to switch the source of the Run command (H1-□□ = 2), then the Run command and frequency reference will be supplied by parameters b1-15 and b1-16 when that terminal is closed.
00EDH	Write frequency reference (RAM)	Writes the frequency reference for the drive to RAM.
00EEH	Write frequency reference (EEPROM)	Writes the frequency reference and all parameter values to EEPROM.
–	Read parameters	Adds 1000H to the MEMOBUS register number.
–	Parameter settings	Master executes commands by adding 2000H to the MEMOBUS register number. Conversion takes place on the option unit side.
00F4H	Clear all fault contents	9696H: Clear fault history
00FDH	Reset drive	9696H: Fault reset

◆ Extended Command Codes

Table 20 Extended Command Codes

Command Code		Name	
Read	Write	BIT	
100H	-	Operation signals	
		0	H5-12 = 0: Forward run command (0 = Stop, 1 = Forward run) H5-12 = 1: Run command (0 = Stop, 1 = Run)
		1	H5-12 = 0: Reverse run command (0 = Stop, 1 = Reverse run) H5-12 = 1: Forward/Reverse (0 = Forward, 1 = Reverse)
		2	External fault (EF0)
		3	Fault reset
		4	Multi-function input 1 Bit disabled when H1-01 = 40 (FWD/Stop)
		5	Multi-function input 2 Bit disabled when H1-02 = 41 (REV/Stop)
		6	Multi-function input 3
		7	Multi-function input 4
		8	Multi-function input 5
		9	Multi-function input 6
		A	Multi-function input 7
		B to F	Reserved
		101H	-
102H	202H	Torque reference / torque limit	
103H	203H	Torque compensation	
104H	204H	PID setpoint	
105H	205H	Analog output terminal AM	
107H	207H	Multi-function relay output	
109H	209H	Pulse output	
110H	-	Status signal	
		0	During run
		1	During zero speed
		2	During reverse
		3	During fault reset signal input
		4	During speed agree
		5	Drive Ready
		6	Alarm
		7	Fault
		8	During operation error (oPE□□)
		9	During Momentary power loss
		A	NetCtrl status
		B	Multi-function contact output (terminal MA/MB-MC)
		C	Multi-function photocoupler output 1 (terminal P1 - PC)
D	Multi-function photocoupler output 2 (terminal P2 - PC)		
E	Motor 2 selected		
F	Reserved		
111H	-	Speed restore	
112H	-	Through-mode	
114H	-	Frequency reference	
115H	-	Output frequency	
116H	-	Output current	
117H	-	Analog input terminal A1	
118H	-	DC bus voltage	
11CH	-	Analog input terminal A2	
11DH	-	Sequence input	
120H	-	Fault contents 1 <I>	
121H	-	Fault contents 2 <I>	
122H	-	Fault contents 3 <I>	
123H	-	Fault contents 4 <I>	
124H	-	Fault contents 5 <I>	
130H	-	CPF contents 1 <I>	
131H	-	CPF contents 2 <I>	

<I> See [Fault Contents on page 31](#) for information on fault contents.

◆ Monitor Codes

Table 21 Monitor Codes

Monitor Code	Name	Comments
0000H	Reserved	
0001H	Output frequency	Units are determined by o1-03.
0002H	Output current	Units are either 0.1 A or 0.01 A, depending on the capacity of the drive.
0003H	Output voltage reference	Units: 0.1 V
0004H	Reserved	
0005H	Frequency reference	Units are determined by o1-03.
0006H	Motor speed	Units: 1 min ⁻¹
0007H	Motor torque	Units: 0.1%
0008H	DC bus voltage	Units: 1 V
0009H	Reserved	
000AH	Reserved	
000BH	Reserved	
000CH	Reserved	
000DH	Reserved	
000EH	Output power	Units: 0.1 kW
000FH	Input terminal status	<p>7 6 5 4 3 2 1 0 RW 1: ON 0: OFF</p> <ul style="list-style-type: none"> Multi-Function Digital Input 1 (terminal S1 enabled) Multi-Function Digital Input 2 (terminal S2 enabled) Multi-Function Digital Input 3 (terminal S3 enabled) Multi-Function Digital Input 4 (terminal S4 enabled) Multi-Function Digital Input 5 (terminal S5 enabled) Multi-Function Digital Input 6 (terminal S6 enabled) Multi-Function Digital Input 7 (terminal S7 enabled) Not used
0010H	Output terminal status	<p>7 6 5 4 3 2 1 0 RW 1: ON 0: OFF</p> <ul style="list-style-type: none"> Multi-Function Digital Output (terminal MA/MB-MC) enabled Multi-Function Digital Output 1 (terminal P1) enabled Multi-Function Digital Output 2 (terminal P2) enabled Not used
0011H	Reserved	
0012H	Motor excitation current	Units: 0.1%
0013H	Reserved	
0014H	Cumulative operation time	<ul style="list-style-type: none"> Units: 1 hour Parameter o4-02 determines if the operation time is the considered to be whenever the drive powered on or only when there is voltage output.
0015H	Reserved	
0016H	Reserved	
0017H	Actual operation time	<ul style="list-style-type: none"> Units: 1 hour Parameter o4-02 determines if the operation time is the considered to be whenever the drive powered on or only when there is voltage output.
0018H	Motor secondary current	
0019H	Reserved	
0034H	PID setpoint	Units: 0.1%
0035H	PID input	Units: 0.1%
0036H	PID output	Units: 0.1%
1000H	Reserved	
1001H	Reserved	
1002H	Cumulative operation time	
1003H	Watt-hour output (lower digits)	
1004H	Watt-hour output (upper digits)	
1010H	Alarm code	
1011H	Fault code	
1012H	Reserved	
1013H	Fault contents 1 </>	
1014H	Fault contents 2 </>	
1015H	Fault contents 3 </>	
1016H	Fault contents 4 </>	
1017H	Fault contents 5 </>	

Monitor Code	Name	Comments
101CH	CPF contents 1 </!>	
101DH	CPF contents 2 </!>	
101EH	Reserved	
101FH	Alarm contents 1	
1020H	Alarm contents 2	
1021H	Alarm contents 3	
1022H	Alarm contents 4	
1023H	Alarm contents 5	
1027H	Output frequency when fault occurred	
1028H	Output frequency when fault occurred	
1029H	Output voltage when fault occurred	
102AH	Total operation time when fault occurred	

<1> See [Fault Contents on page 31](#) for information on fault contents.

◆ Fault Contents

Table 22 Fault Contents

Extended Command Code (Monitor Code)	Fault Name		Fault Code (U2, U3)
	BIT		
120H (1013H)	Fault contents 1		
	0	Reserved	–
	1	Undervoltage (Uv1)	0002H
	2	Control power supply undervoltage (Uv2)	0003H
	3	Softcharge circuit fault (Uv3)	0004H
	4	Load short-circuit (SC)	0005H
	5	Ground fault (GF)	0006H
	6	Overcurrent (oC)	0007H
	7	Overvoltage (ov)	0008H
	8	Heatsink overheat (oH)	0009H
	9	Heatsink overheat (oH1)	000AH
	A	Motor overload (oL1)	000BH
	B	Drive overload (oL2)	000CH
	C	Overtorque detection 1 (oL3)	000DH
	D	Overtorque detection 2 (oL4)	000EH
E	Dynamic braking transistor (rr)	000FH	
F	Braking resistor overheat (rH)	0010H	
121H (1014H)	Fault contents 2		
	0	External fault (input terminal S3) (EF3)	0011H
	1	External fault (input terminal S4) (EF4)	0012H
	2	External fault (input terminal S5) (EF5)	0013H
	3	External fault (input terminal S6) (EF6)	0014H
	4	External fault (input terminal S7) (EF7)	0015H
	5	Reserved	–
	6	Reserved	–
	7	Overspeed (oS) Note: Possible only when using Simple V/f with PG	0018H
	8	Excessive speed deviation (dEv) Note: Possible only when using Simple V/f with PG	0019H
	9	PG disconnect (PGo) Note: Possible only when using Simple V/f with PG	001AH
	A	Input phase loss (PF)	001BH
	B	Output phase loss (LF)	001CH
	C	Motor overheat (PTC input) (oH3)	001DH
	D	Digital operator connection fault (oPr)	001EH
E	EEPROM write error (Err)	001FH	
F	Motor overheat fault (PTC input) (oH4)	0020H	

10 CC-Link Code Numbers

Extended Command Code (Monitor Code)	Fault Name		Fault Code (U2, U3)
	BIT		
122H (1015H)	Fault contents 3		
	0	MEMOBUS communication fault (CE)	0021H
	1	Option communications error (bUS)	0022H
	2	Reserved	–
	3	Reserved	–
	4	Control fault (CF)	0025H
	5	Reserved	–
	6	Option unit external fault (EF0)	0027H
	7	PID feedback loss (FbL)	0028H
	8	Undertorque detection 1 (UL3)	0029H
	9	Undertorque detection 2 (UL4)	002AH
	A	High Slip Braking overload (oL7)	002BH
	B	Reserved	–
	C	Reserved	–
	D	Reserved	–
	E	Reserved	–
F	Hardware fault (including oFx)	0030H	
123H (1016H)	Fault contents 4		
	0	Reserved	–
	1	Reserved	–
	2	Reserved	–
	3	Reserved	–
	4	Reserved	–
	5	Output current imbalance (LF2)	0036H
	6	Pullout detection (STo)	0037H
	7	Reserved	–
	8	Reserved	–
	9	Reserved	–
	A	Too many speed search restart (SEr)	003BH
	B	Reserved	–
	C	Reserved	–
	D	Reserved	–
	E	Reserved	–
F	Reserved	–	
124H (1017H)	Fault contents 5		
	0	Excessive PID feedback (FbH)	0041H
	1	External fault (input terminal S1) (EF1)	0042H
	2	External fault (input terminal S2) (EF2)	0043H
	3	Mechanical weakening detection 1 (oL5)	0044H
	4	Mechanical weakening detection 2 (UL5)	0045H
	5	Current offset fault (CoF)	0046H
	6	Reserved	–
	7	Reserved	–
	8	DriveWorksEZ fault (dWFL)	0049H
	9	Reserved	–
	A	Reserved	–
	B	Reserved	–
	C	Reserved	–
	D	Reserved	–
	E	Reserved	–
F	Reserved	–	

Extended Command Code (Monitor Code)	Fault Name		Fault Code (U2, U3)
	BIT		
130H (101CH)	CPF contents 1		
	0	Reserved	–
	1	Reserved	–
	2	A/D conversion error (CPF02)	0083H
	3	PWM data error (CPF03)	0084H
	4	Reserved	–
	5	Reserved	–
	6	EEPROM data error (CPF06)	0087H
	7	Terminal board communication error (CPF07)	0088H
	8	EEPROM serial communication fault (CPF08)	0089H
	9	Reserved	–
	A	Reserved	–
	B	RAM fault (CPF11)	008CH
	C	Flash memory fault (CPF12)	008DH
	D	Watchdog circuit exception (CPF13)	008EH
	E	Control circuit fault (CPF14)	008FH
F	Reserved	–	
131H (101DH)	CPF contents 2		
	0	Clock fault (CPF16)	0091H
	1	Timing fault (CPF17)	0092H
	2	Control circuit fault (CPF18)	0093H
	3	Control circuit fault (CPF19)	0094H
	4	Hardware fault at power up (CPF20)	0095H
	5	Hardware fault at communication start up (CPF21)	0096H
	6	A/D conversion fault (CPF22)	0097H
	7	PWM feedback fault (CPF23)	0098H
	8	Drive capacity signal fault (CPF24)	0099H
	9	Reserved	–
	A	Reserved	–
	B	Reserved	–
	C	Reserved	–
	D	Reserved	–
	E	Reserved	–
F	Reserved	–	

11 Specifications

◆ Specifications

Table 23 Option Specifications

Model	SI-C3/V (PCB model: SI-C3)
CC-Link Version	Version 1.10
Station Type	Remote device station
No. of Occupied Stations	1
Communication Speed	156 kbps to 10 Mbps
Ambient Temperature	-10°C to +50°C
Humidity	up to 95% RH (no condensation)
Storage Temperature	-20°C to +60°C (allowed for short-term transport of the product)
Area of Use	Indoors (free of corrosive gas, airborne particles, etc.)
Altitude	Up to 1000 m

Note: The number of drives that can be connected to the network varies depending on the type of nodes connected. See page 18 for more information.

◆ Revision History

The revision dates and numbers of the revised manuals are given on the bottom of the back cover.



MANUAL NO. SIEP C730600 22A

Published in Japan January 2008 07-6 

└─ Revision number

└─ Date of original publication

└─ Date of publication

Date of Publication	Rev. No.	Section	Revised Content
June 2007	—	—	First edition
January 2008		Back cover	Revision: Address
April 2008		All	Revision: Reviewed and corrected entire document (including table of contents)
		Chapter 2	Revision: Applicable model (software version 1010 to 1011 or later)
		Chapter 4	Addition: Table 4 CC-Link Operation LED Status
		Chapter 6	Addition: Parameter F6-07 and F6-08 Revision: F6-04 default setting (0.05 s → 0.0 s)
		Chapter 8	Revision: Table 10/11 Remote I/O Table
		Chapter 9	Addition: Fault - oFA30 to oFA43 Minor Faults and Alarms - AEr, CALL
		Chapter 10	Deletion: Monitor Data and MEMOBUS Message Area, Alarm Contents

YASKAWA AC Drive-V1000 Option

CC-Link

Technical Manual

IRUMA BUSINESS CENTER (SOLUTION CENTER)

480, Kamifujisawa, Iruma, Saitama 358-8555, Japan
Phone 81-4-2962-5696 Fax 81-4-2962-6138

YASKAWA ELECTRIC AMERICA, INC.

2121 Norman Drive South, Waukegan, IL 60085, U.S.A.
Phone 1-847-887-7000 Fax 1-847-887-7370

YASKAWA ELÉTRICO DO BRASIL LTDA.

Avenida Fagundes Filho, 620 São Paulo-SP CEP 04304-000, Brazil
Phone 55-11-3585-1100 Fax 55-11-5581-8795

YASKAWA ELECTRIC EUROPE GmbH

Am Kronberger Hang 2, 65824 Schwalbach, Germany
Phone 49-6196-569-300 Fax 49-6196-569-312

YASKAWA ELECTRIC UK LTD.

1 Hunt Hill Orchardton Woods Cumbernauld, G68 9LF, United Kingdom
Phone 44-1236-735000 Fax 44-1236-458182

YASKAWA ELECTRIC KOREA CORPORATION

7F, Doore Bldg. 24, Yeoido-dong, Youngdungpo-Ku, Seoul 150-877, Korea
Phone 82-2-784-7844 Fax 82-2-784-8495

YASKAWA ELECTRIC (SINGAPORE) PTE. LTD.

151 Lorong Chuan, #04-01, New Tech Park 556741, Singapore
Phone 65-6282-3003 Fax 65-6289-3003

YASKAWA ELECTRIC (SHANGHAI) CO., LTD.

No.18 Xizang Zhong Road, Room 1702-1707, Harbour Ring Plaza Shanghai 200001, China
Phone 86-21-5385-2200 Fax 86-21-5385-3299

YASKAWA ELECTRIC (SHANGHAI) CO., LTD. BEIJING OFFICE

Room 1011A, Tower W3 Oriental Plaza, No.1 East Chang An Ave.,
Dong Cheng District, Beijing 100738, China
Phone 86-10-8518-4086 Fax 86-10-8518-4082

YASKAWA ELECTRIC TAIWAN CORPORATION

9F, 16, Nanking E. Rd., Sec. 3, Taipei, Taiwan
Phone 886-2-2502-5003 Fax 886-2-2505-1280



YASKAWA

YASKAWA ELECTRIC CORPORATION

In the event that the end user of this product is to be the military and said product is to be employed in any weapons systems or the manufacture thereof, the export will fall under the relevant regulations as stipulated in the Foreign Exchange and Foreign Trade Regulations. Therefore, be sure to follow all procedures and submit all relevant documentation according to any and all rules, regulations and laws that may apply.

Specifications are subject to change without notice for ongoing product modifications and improvements.

© 2007-2008 YASKAWA ELECTRIC CORPORATION. All rights reserved.

MANUAL NO. SIEP C730600 22B

Published in Japan April 2008 07-6 -0
07-11-2